

RENAULT SYMBIOZ E-TECH FULL HYBRID

145 HP



17 December 2024



technology that reconnects you

The ultimate lifestyle car, Renault Symbioz combines all the advantages of a compact vehicle with those of a family car. The interior is both technologically advanced and comfortable to ensure your well-being, with generous interior space, Solarbay® opacifying panoramic sunroof⁽¹⁾, premium Harman Kardon® sound⁽¹⁾ and the openR link multimedia system.



When technology meets interior comfort for an enhanced on-board experience.

Solarbay® opacifying panoramic sunroof⁽¹⁾

openR link system with Google built-in⁽⁴⁾

up to 24 advanced driver-assistance systems⁽⁵⁾

up to 624 litres⁽²⁾ of boot volume⁽³⁾

E-Tech full hybrid 145 hp engine

up to 645 miles of driving range⁽⁶⁾

(1) only available on iconic esprit Alpine. (2) with bench seat forwards. (3) the equivalent volume measured according to VDA standard (ISO 3832) is 548 dm³ for the E-Tech full hybrid version (the VDA standard involves measuring the total volume of the boot using standardised shape and volume objects (200 mm x 100 mm x 50 mm = 1 dm³)). (4) Google, Google Maps, Google News, Waze and other marks are trademarks of Google LLC. (5) depending on version. (6) WLTP figures shown for comparability purposes only. Actual real world driving results may vary depending on factors including the fullness of the tank, starting charge of the battery, accessories fitted after registration, weather conditions, driving styles and vehicle load / source: internal Renault, 2024, techno vs WLTP fuel consumption figures.

interactive menu

01. design

02. on-board experience

03. multimedia

04. spaciousness

05. driving pleasure

06. safety

07. customisation

pdf to be downloaded

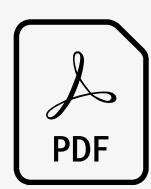

equipment and engine options

avant-garde elegance

Its assertive personality defines the exterior style of Renault Symbioz. A long coupé, its dimensions remain compact to adapt to your needs. With its robust and refined grille with the new Renault identity, satin chrome logo and half-diamond lights, each element of the design accentuates its charisma.



The radiator grille, made up of micro-diamonds, is adorned with a graphic effect. At the rear, the Symbioz signature emphasises the sharp lines.



esprit Alpine

The Alpine spirit stands out through a number of distinctive features, including the matte grey F1 strip.



Special 19" esprit Alpine 'elixir' wheels and Alpine badge on the front wings for more sportiness. On board, the upholstery is stitched in the iconic Alpine blue and the distinctive badge features a blue/white/red flag on the seat backs and dashboard.

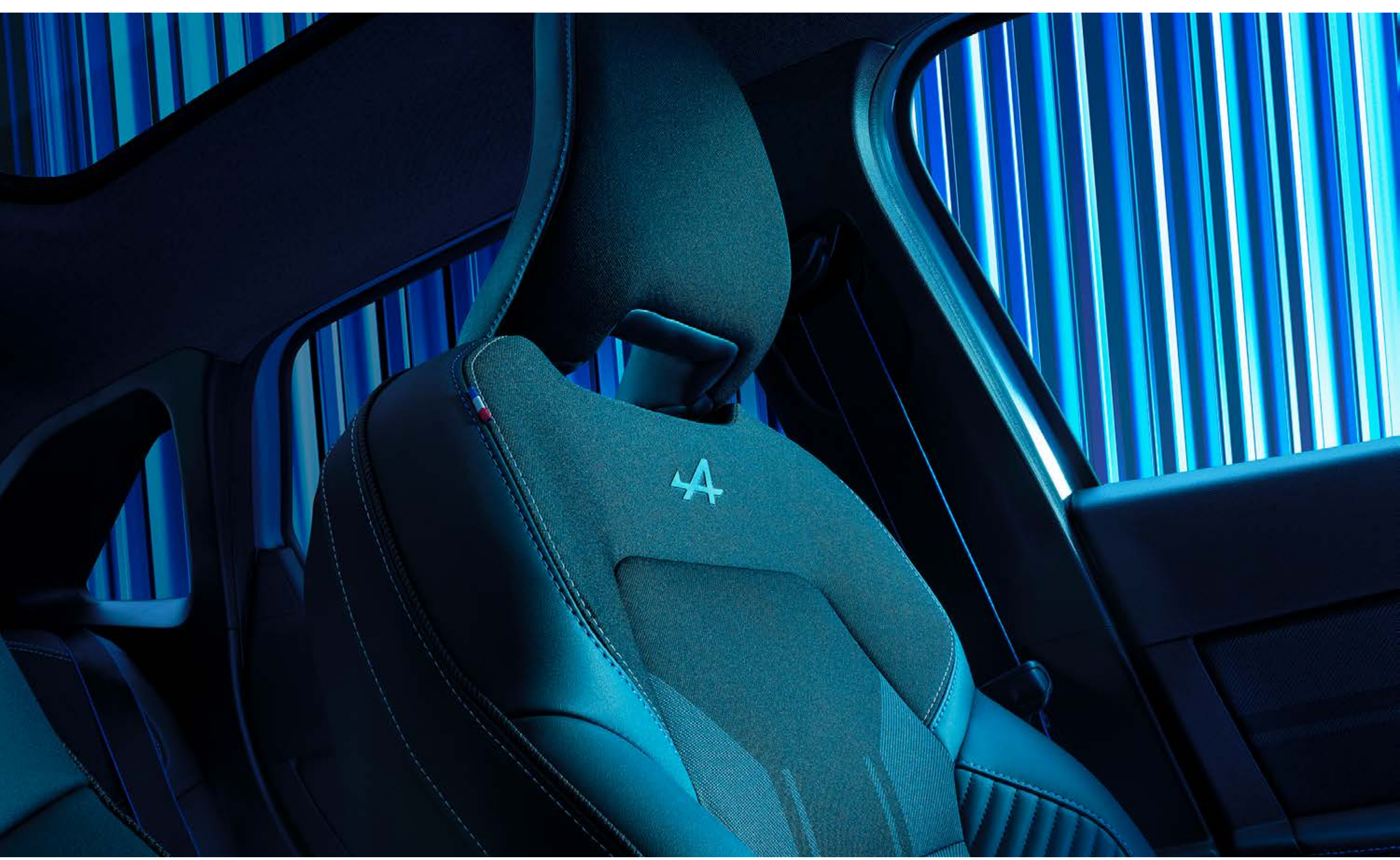

[configure and order →](#)

connect with well-being

Take a seat in a high-tech cockpit that enhances driving pleasure. With its steering wheel controls, the dashboard is streamlined and driving is simplified. Every passenger can enjoy the innovative view offered by the Solarbay® opacifying panoramic sunroof⁽¹⁾ and the customised sound environment created by Harman Kardon®⁽¹⁾. Whatever the journey, share the fun with family and friends.

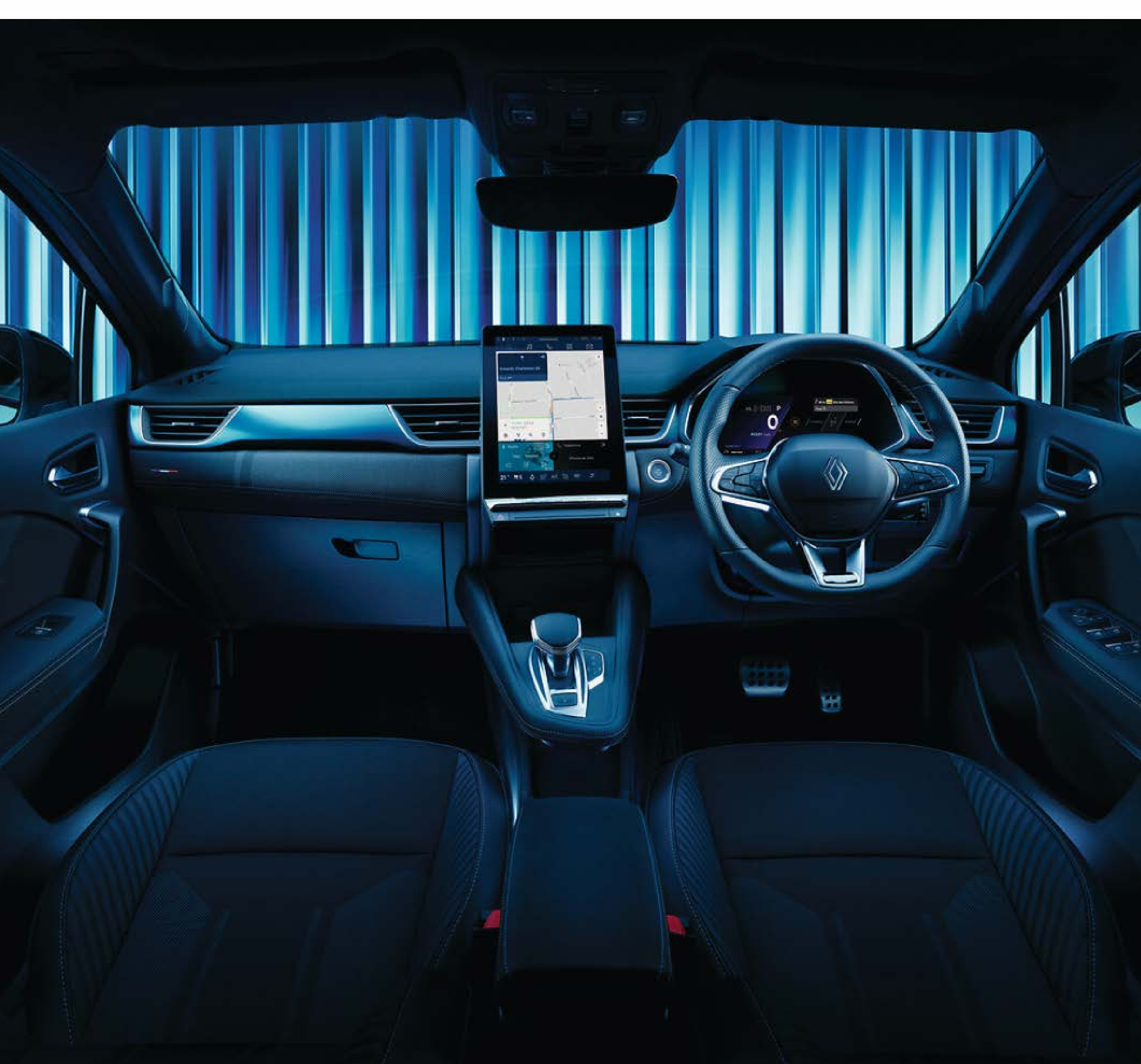

The Solarbay® technology can be activated by voice using Google Assistant⁽²⁾ or manually using a button on the ceiling light. Adjustable to 4 different opacity configurations, it maintains light and heat comfort on board in both summer and winter.



The passenger compartment has a wireless charging point. Lay down your smartphone and your device stays charged wirelessly without interruption.



(1) available on iconic esprit Alpine. (2) Google, Google Maps, Google News, Waze and other marks are trademarks of Google LLC. My Renault, Google Maps and Google Assistant connected services are provided free of charge for 5 years from the date of delivery of your vehicle. The use of applications downloaded from Google Play requires a dedicated data package. To use apps, share your phone's connection with your Renault.

Immerse yourself in the exclusive Harman Kardon® sound⁽¹⁾ experience and enjoy the most beautiful emotions: 9 speakers distributed throughout the cabin and designed to deliver the same captivating sound quality in each seat.

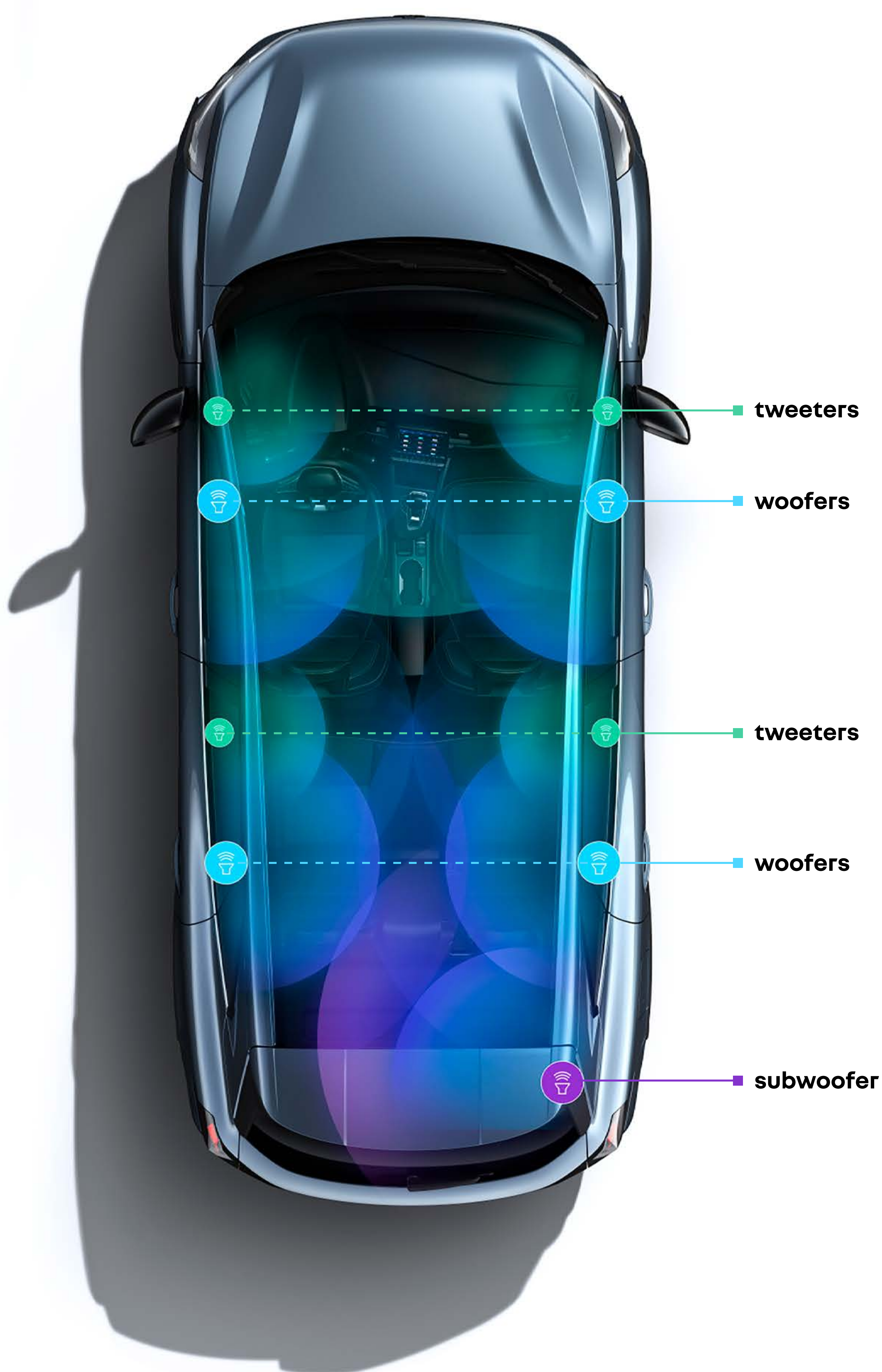

(1) available on iconic esprit Alpine.

configure and order →

openR link multimedia system with Google built-in

The 10.4" central display and the 10.25" digital driver display connect you to the best of technology thanks to the openR link multimedia system with Google built-in⁽¹⁾.

Enjoy more than 50 apps for a shared experience⁽¹⁾.



Google Maps⁽²⁾ provides accurate navigation even if the network goes down, informing you of road closures, changes to the direction of traffic, road works, etc.

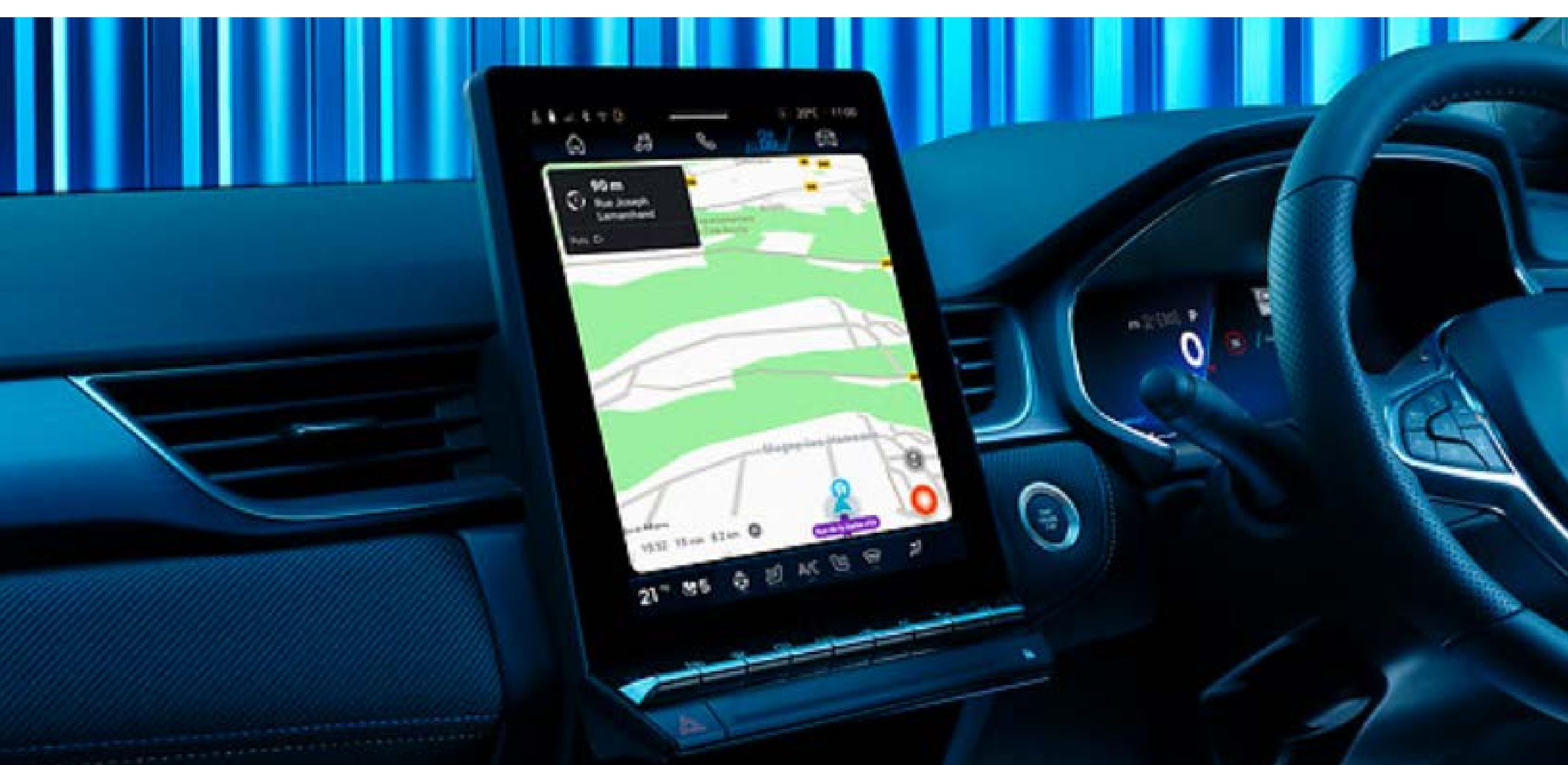

"Hey Google..." Talk to it to plan a trip, adjust vehicle temperature or adjust the opacity of the Solarbay[®] panoramic sunroof. The voice assistant is there for you.



Over 50 apps with exclusive content are available via Google Play⁽³⁾, including Waze, SongPop for Renault, and Amazon Music.



Waze is a community-based navigation app that shares information in real time. Waze boosts your peace of mind.



Drive to the beat with our new musical game - **SongPop** for Renault. Play together and rediscover popular songs with your family and friends!

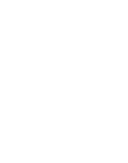

Take to the road while listening to playlists, and much more, with **Amazon Music**, included with your Amazon Prime subscription.



With **EasyPark**, you can plan and book millions of parking spaces across Europe. Enter your destination's address or navigate using the map.



Vivaldi browser is an efficient, fast Web browser that respects your privacy.



Access all your favourite radio stations live, at any time, in France or abroad, with **RadioPlayer**.

(1) Google, Google Maps, Google News, Waze and other marks are trademarks of Google LLC.
(2) My Renault, Google Maps and Google Assistant connected services are provided free of charge for 5 years from the date of delivery of your vehicle.
(3) The use of applications downloaded from Google Play requires a dedicated data package. To use apps, share your phone's connection with your Renault.

[configure and order →](#)

the space adapts to you

The spacious passenger compartment has the ideal dimensions and modular design for perfect versatility, with electric front seats⁽¹⁾, 22 cm of legroom in the rear and a folding rear bench seat. The innovative upholstery with bio-sourced materials combines comfort and elegance.



With the rear bench seat folded down, you have a total volume of 1,582 litres⁽²⁾ to carry your luggage, groceries or equipment. The practical handsfree system allows the tailgate to be opened with one foot movement⁽¹⁾.



Save space in a flash. Thanks to the sliding rear bench seat with 16 cm of travel, the boot capacity is increased from 492 litres to 624 litres⁽³⁾.

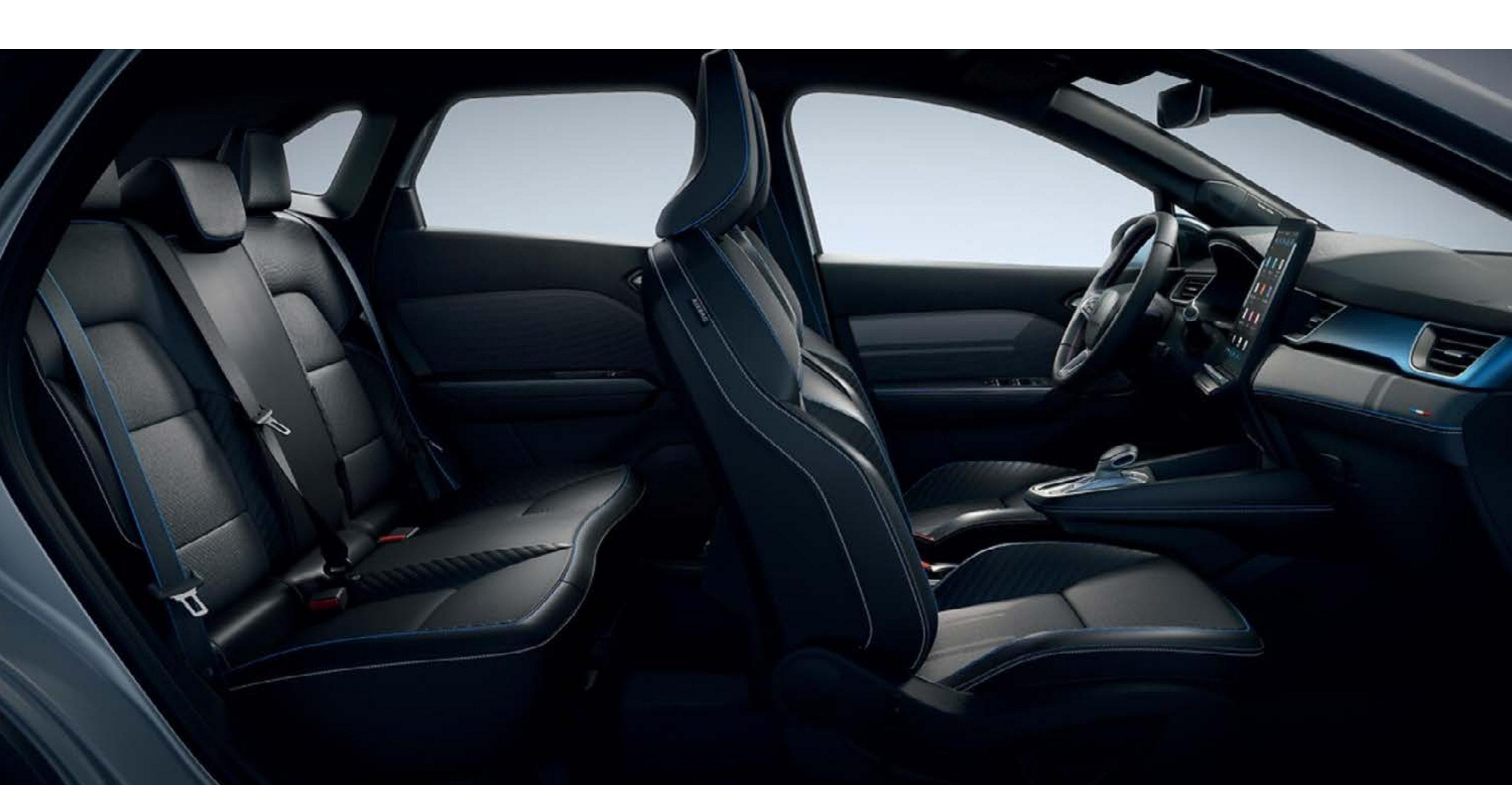

(1) on techno esprit Alpine and iconic esprit Alpine. (2) with bench seat folded down, VDA measurement of max boot volume (1498). (3) VDA measurements for these (434 and 548).

[configure and order →](#)

05. driving pleasure

E-Tech full hybrid engine

E-Tech
full hybrid
145 hp

up to
645 miles
of driving range⁽¹⁾

up to
61.4 mpg
of fuel consumption⁽²⁾

from
105 g/km
CO₂ emissions⁽³⁾



Treat yourself to hybrid driving with Renault Symbioz. Enjoy dynamic acceleration while reducing your fuel consumption and CO₂ emissions. Thanks to regenerative braking, the battery recharges automatically when you brake or decelerate. No need to plug your vehicle into a power outlet.



(1) WLTP figures shown for comparability purposes only. Actual real world driving results may vary depending on factors including the fullness of the tank, starting charge of the battery, accessories fitted after registration, weather conditions, driving styles and vehicle load / source: internal Renault, 2024, techno vs WLTP fuel consumption figures. (2) in WLTP combined cycle. (3) according to WLTP data.

configure and order →

06. safety



up to 24 advanced driver assistance systems⁽¹⁾⁽²⁾

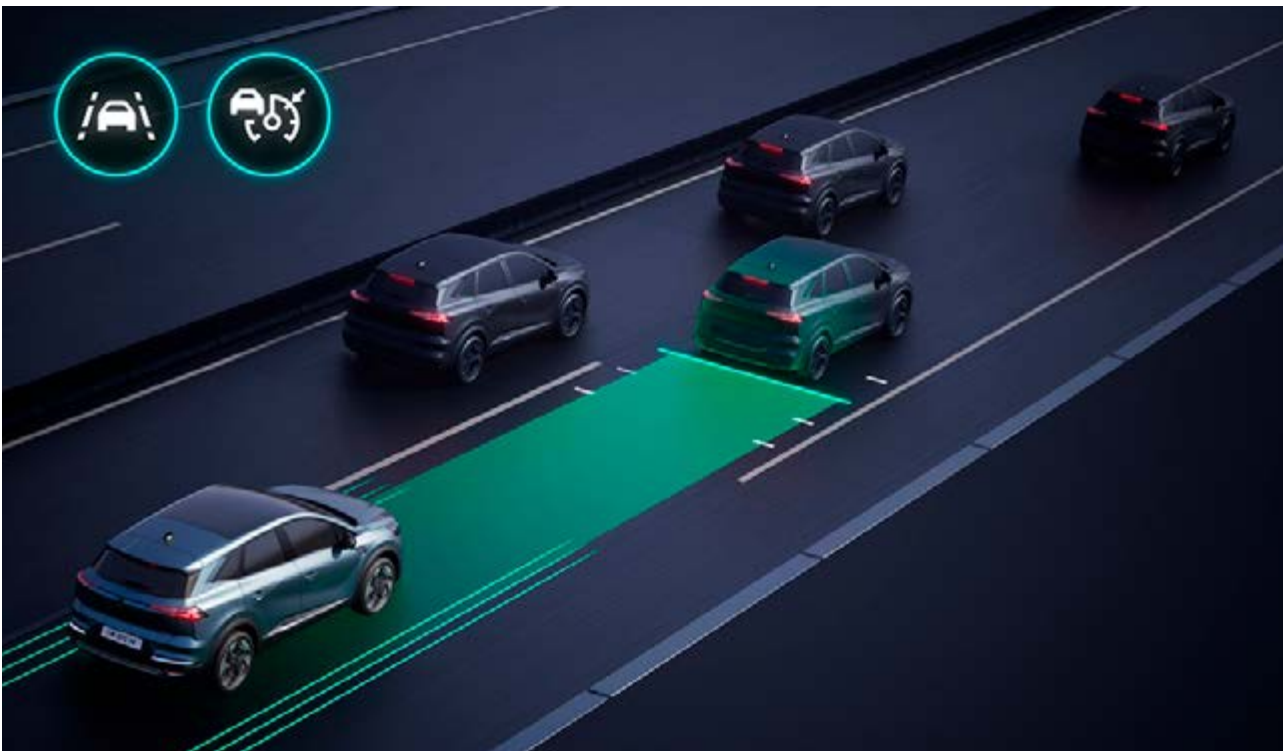

active driver assist

This system regulates your speed by taking the road environment into account, maintains safe distances and ensures you remain in lane. When traffic slows down, the vehicle stops and restarts automatically.

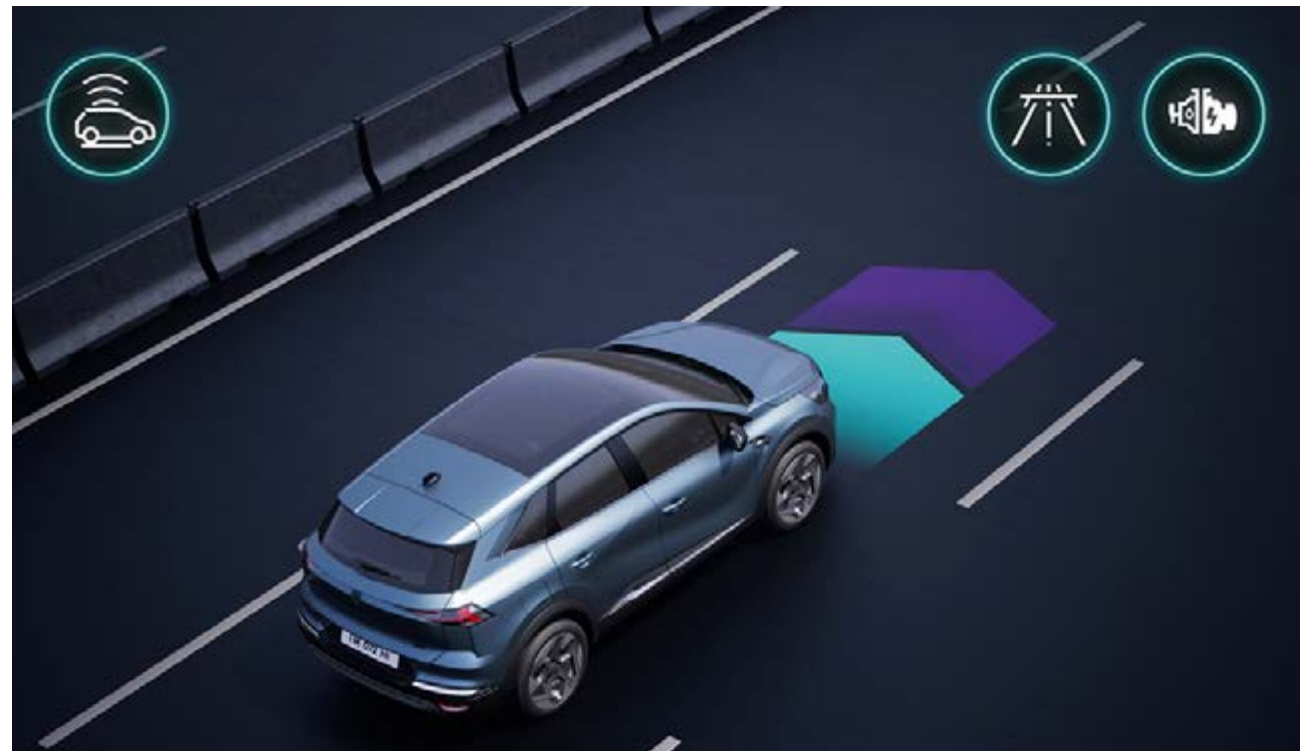

predictive hybrid driving

Your car anticipates combustion engine, hybrid or 100% electric driving by continuously analysing your route to establish the time at which you shall drive through a town or whether you risk encountering a particular topography or a traffic jam. As a result, you improve the fuel consumption and performance of your vehicle.



360° around view 3D camera

The 4 cameras, whose images recreate the vehicle's direct environment 360° around it, allow you to perform your manoeuvres effortlessly.



rear active emergency braking

This system detects obstacles at the rear and stops the vehicle automatically in the event of danger.

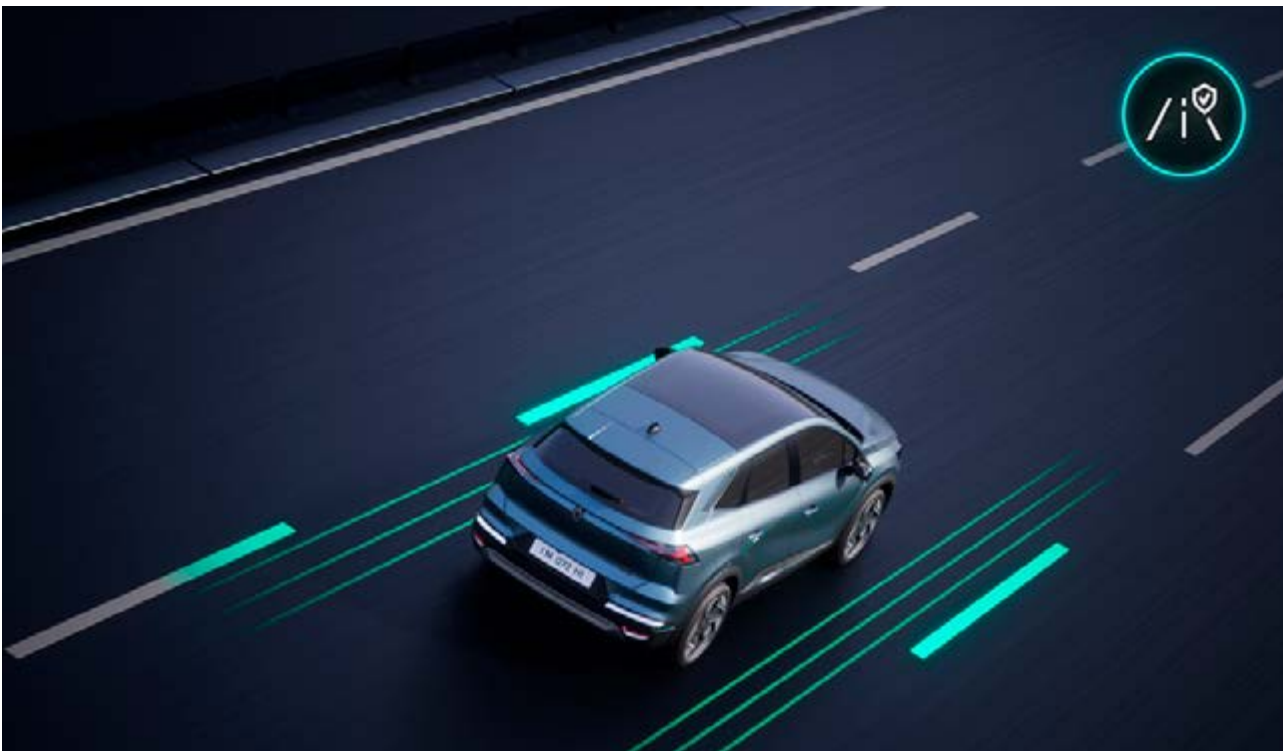

lane keeping assist

This system corrects the angle of the steering wheel, returning the vehicle to its lane unless you have indicated.



occupant safe exit alert

This system alerts you if a vehicle is approaching from the rear when you want to open the door.

driver assistance

- active driver assist
- hill start assist
- distance warning alert
- predictive eco-driving assistant
- predictive hybrid driving
- speed limiter
- adaptive cruise control

park assist systems

- rear parking sensors
- front parking sensors
- side parking sensors
- rear view camera
- 360° around view 3D camera
- handsfree parking

safety assistance systems

- lane departure warning
- occupant safe exit alert
- lane keeping assist
- blind spot warning and rear detection with emergency lane keep assist
- rear cross traffic alert
- automatic high/low beam
- front & rear detection with emergency lane keep assist [including solid line, oncoming traffic & road edge detection]
- traffic sign recognition with overspeed prevention
- driver attention alert

(1) Always follow road safety regulations. It is your responsibility to stay alert, drive safely and be in control of the vehicle at all times. You should not solely rely on driver convenience and assistance features. Some features may not work in all conditions and circumstances, and they have speed and other limitations. (2) advanced driver-assistance systems dependent on version. Please check full equipment list for more details.

[configure and order →](#)

07. customisation

colours



mercury blue⁽¹⁾



oyster grey



ceramic grey



diamond black



arctic white



flame red⁽²⁾



iron blue

(1) not available on esprit Alpine versions. (2) standard paint on all versions.

configure and order →

07. customisation

interior trims



techno

- granite grey decorative upper strip
- height-adjustable driver and passenger seats
- 10.4" openR link: connected multimedia system with Google built-in
- 10.25" digital driver display



techno esprit Alpine (techno +)

- brushed blue decorative upper strip
- heated front seats
- Alpine marking and red, white & blue flag on front seats
- heated synthetic leather steering wheel
- aluminium sports pedals
- electrically adjustable front seats



iconic esprit Alpine (techno esprit Alpine+)

- Solarbay® opacifying panoramic sunroof
- Harman Kardon premium audio
- handsfree parking
- 360° around view 3D camera



**download the PDF (6 MB)
of the trims and equipment**

07. customisation

upholstery



embossed marled black fabric / titanium black biosourced grained coated fabric with yellow top-stitching⁽¹⁾



26% recycled fabric / titanium black grained coated fabric with blue top-stitching⁽²⁾

wheels



18" 'gravity' alloy wheels⁽¹⁾



19" esprit Alpine 'elixir' alloy wheels⁽²⁾

(1) techno

(2) esprit Alpine versions

[configure and order →](#)

07. customisation

accessories



side step pack

With premium side steps, enhance your look and easily access loads on the roof.



touring pack

With quickfix roof mounted bars you can easily transport a roof box.



cycle pack

You can also transport a bike with our cycle pack.



protection pack

Pack includes illuminated door sills to enhance the look of your vehicle as well as a boot liner and a boot sill to ensure complete protection.



family pack

Protect your seats from car seat indentation and muddy shoes, along with the multifunction organiser to store all of your everyday items.



elegance pack

Underbody approach light.



swan-neck towbar pack 13-pin



removable towbar pack 13-pin

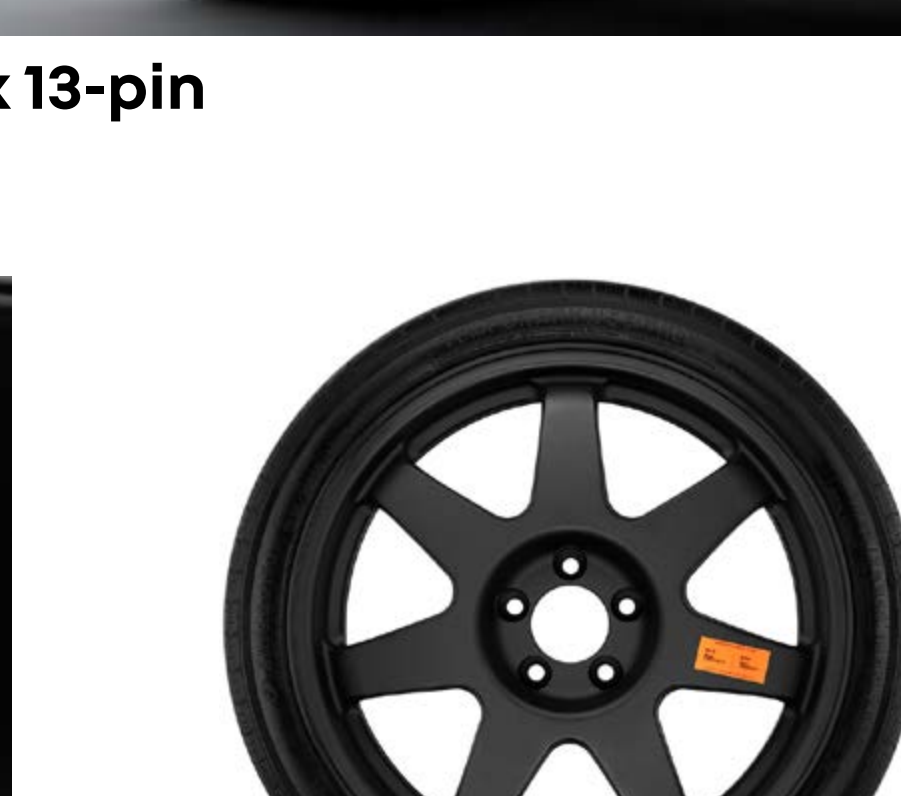
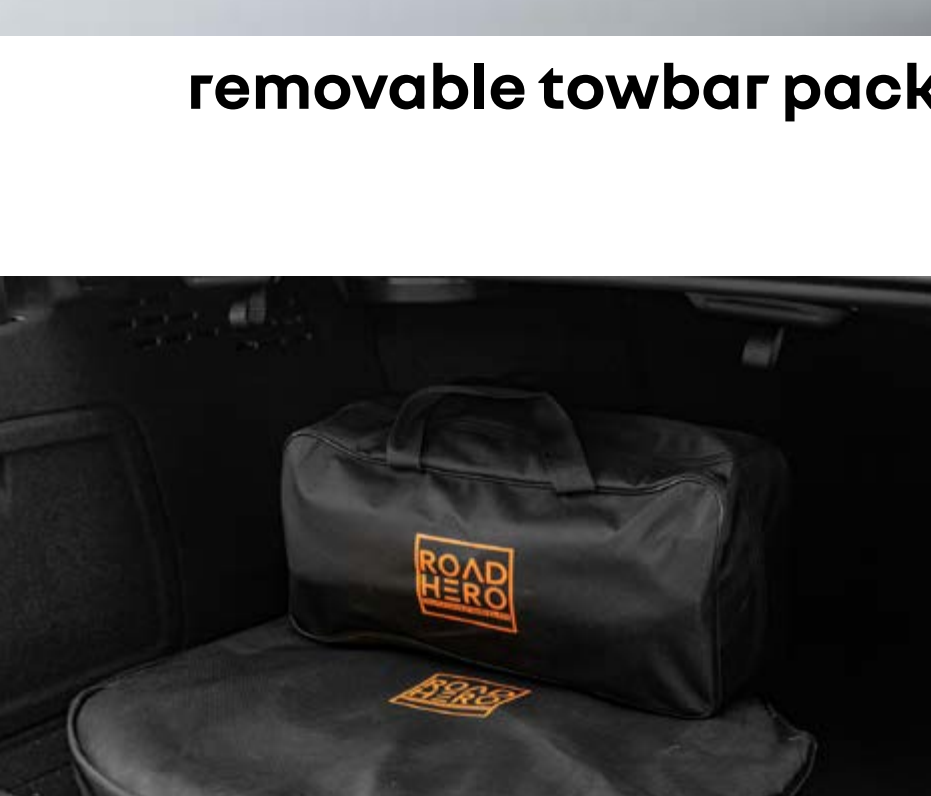

spare wheel kit



dash cam pack

Front and rear dashcam

[configure and order →](#)

07. customisation

engine

E-Tech full hybrid 145

fuel

unleaded fuel (E10) + electric

maximum power kW (hp)

105 kW (145)

maximum torque (Nm)

149 at 3,600 rpm (internal combustion engine) + 205 (electric motor)

gearbox

automatic (clutchless smart multimode)

kerb weight (excluding 75 kg driver weight) (kg) techno / techno esprit Alpine / iconic esprit Alpine

1426 / 1432 / 1447

battery

type

lithium-ion (68 cells)

voltage (V)

150 - 285

capacity (kWh)

1.26

fuel consumption and emissions

combined consumption (mpg)

up to 61.4

combined WLTP consumption (L/100 km)

from 4.6

combined WLTP CO₂ (g/km)

105-107



**download the
engines pdf (6 MB)**

dimensions and volumes

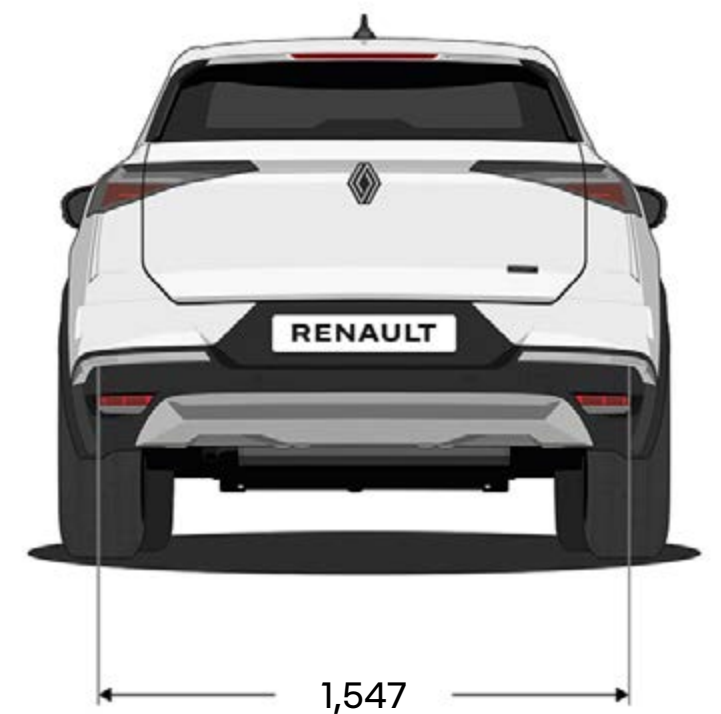
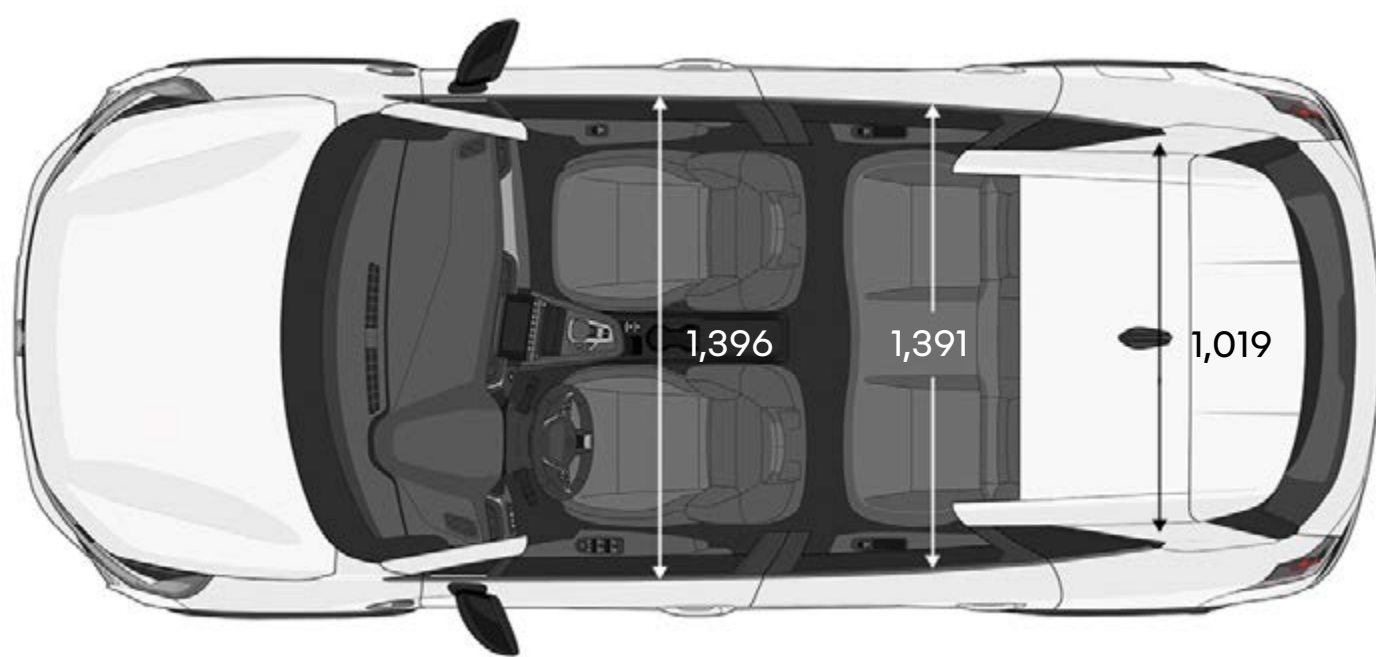
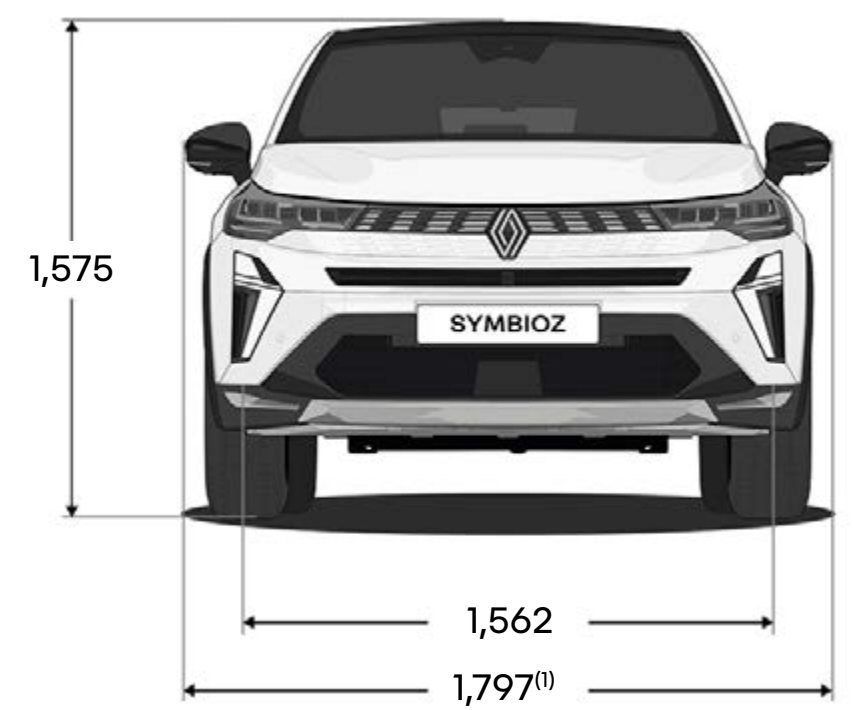
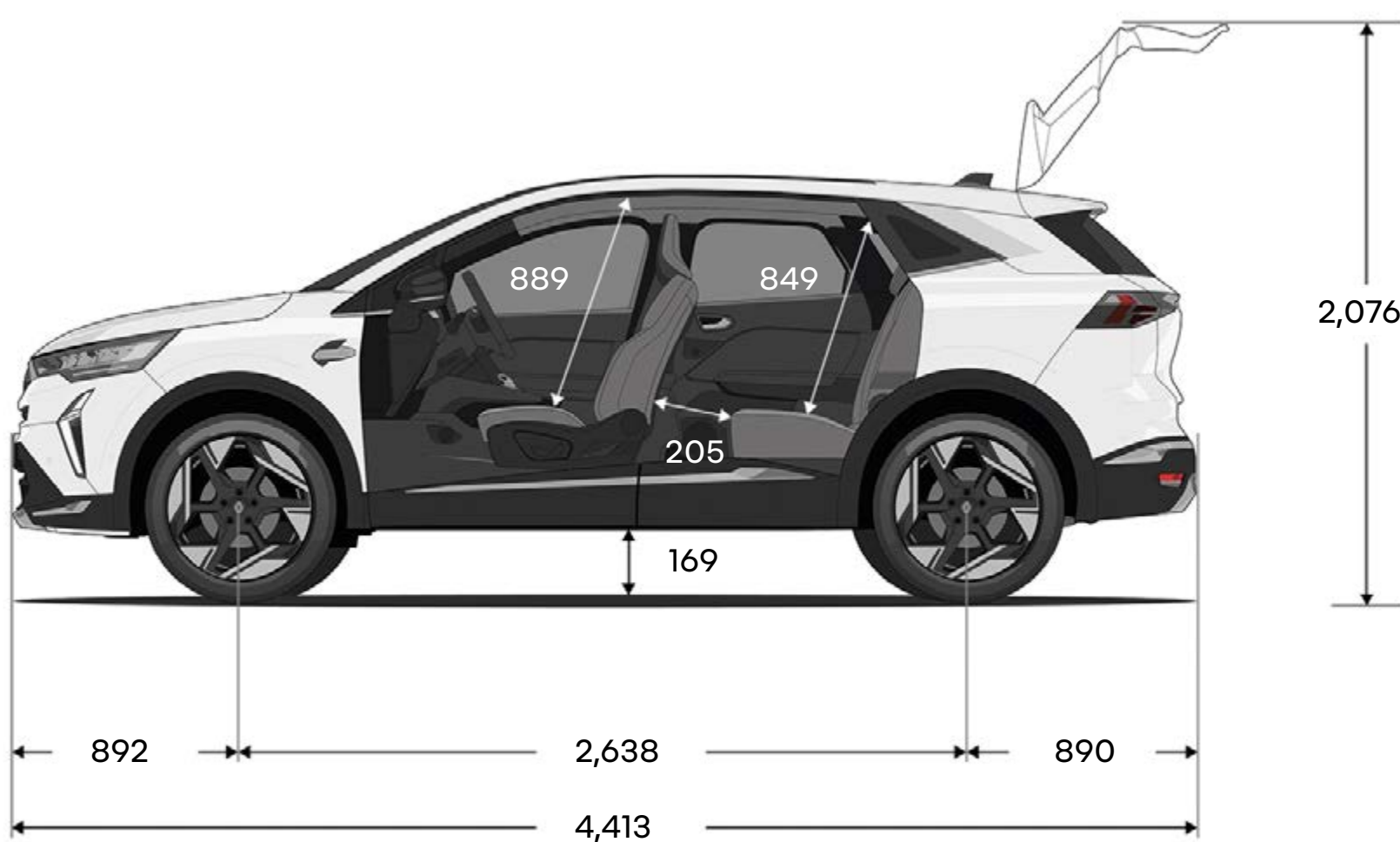

boot volume (in litres)⁽²⁾

boot volume, bench seat in rear position	492
boot volume, bench seat in forward position	624
boot volume, bench seat folded down	1,582

dimensions in (mm).

(1) door mirrors folded. (2) the equivalent volume measured according to VDA standard (ISO 3832) is 434, 548, 1498 dm³ for the E-Tech full hybrid version (the VDA standard involves measuring the total volume of the boot using standardised shape and volume objects (200 mm x 100 mm x 50 mm = 1 dm³)).

[configure and order →](#)

Renault care service

Replace what is necessary, at the right time. Thanks to its connected and predictive maintenance features, it is easy to service your Renault Symbioz. And thanks to the My Renault app, quotes, online appointments and even service history are at your fingertips.

[find out more about Renault care service](#)



Every precaution has been taken to ensure that the contents of this brochure were accurate and up to date at the time of its release. This document was created using pre-production models and prototypes. In line with its policy of continuous product improvement, Renault reserves the right to modify the specifications, vehicles and accessories described and featured at any time. Any such modifications are communicated to Renault dealers as quickly as possible. Depending on the country of sale, versions may differ and some equipment may be unavailable (standard, optional or accessory). Please contact your local dealer for the latest information. For reasons to do with the medium, the colours featured in this document may differ slightly from those of the actual paintwork or interior trim. All rights reserved. Reproduction in any format and by any means of all or part of this brochure is prohibited without prior written authorisation from Renault.

Publicis - photo credits: © Akatre, Renault Marketing 3D-Commerce - December 2024.
Renault s.a.s, a French simplified joint stock company with a share capital of € 533,941,113.00 / 122-122 quai Le Gallo - 92100 Boulogne-Billancourt Cedex, France - registered on the Trade and Companies Registry (R.C.S.) of Nanterre (Trade & Companies Register) B 780 129 987 / Tel.: 0806 00 20 20.

Renault recommends  **Castrol**



configure and order →